

# NICE GATE HI-SPEED SERIES

THE NEW RANGE OF HI-SPEED MOTORS  
FOR GATE AUTOMATION



Nice



Nice Hi-Speed

**HI-SPEED**  
**FASTER THAN EVER**

THE NEW LINE OF **HIGH-SPEED**  
**AUTOMATIONS** FOR SWING  
AND SLIDING GATES IS BORN.  
**NICE CUTS WAITING TIMES!**

Nice

# HI-SPEED GUARANTEED SECURITY AND EFFICIENCY

**Hi-Speed motors for gate automation.**

The perfect solution where rapid opening and closing manoeuvres are required, ensuring the shortest waiting time and the maximum security.

**Nice, for your comfort.**

**PERSONALITY THROUGH DETAILS.**  
THE ORIGINAL RED RELEASE HANDLE  
STRONGLY IDENTIFIES THE NEW  
HI-SPEED MOTOR RANGE.



> FOR SWING GATES



**WINGO**  
WG3524HS



**TOONA**  
T05024HS / T06024HS



**HYKE**  
HK7024HS / HK7224HS



**FAB**  
MFAB3024HS

> FOR SLIDING GATES



**RUN**  
RUN400HS / RUN1200HS



**ROBUS**  
RB500HS



**ROBUS**  
RB250HS

# A COMPLETE RANGE RESPONDING TO ALL NEEDS

A wide product offer characterised by **versatile installations, precision and reliability** thanks to advanced obstacle detection technology.

Ideal for both residential and industrial applications.



**HI-SPEED** POWERFUL AND SAFE,  
FOR URBAN HIGH-TRAFFIC AREAS



# WINGO 3524 HS

SOLEMYO OPERA BLUEBUS 24V

For hi-speed automation of swing gates with leaves up to 3 m or 200 kg, ideal for residential applications.

24 Vdc electromechanical gear motor, surface mounted, with magnetic encoder.

### Quick manoeuvres:

90° opening in about 10\* seconds.

**Reliable:** the magnetic encoder ensures the safeguard of set values over time and precise obstacle detection.

**Silent:** patented layout of internal parts, fewer moving parts.

**Easy to install:** after the gear motor has been assembled, all electrical connections are made from above.

**Pre-assembled travel stops** on opening.

### Moonclever control unit MC824H:

- simple programming, by means of a single key;
- automatic memorization of limit switches on opening and closing with self-learning function;
- automatic fault diagnostics;
- programming of pause time;
- pedestrian pass door;
- deceleration on opening and closing;
- obstacle detection with dual technology;
- operation in event of power failure by means of optional rechargeable batteries (PS324);
- provision for connection of latest generation resistive sensitive edges.

\*Considering standard installation, excluding acceleration and deceleration.

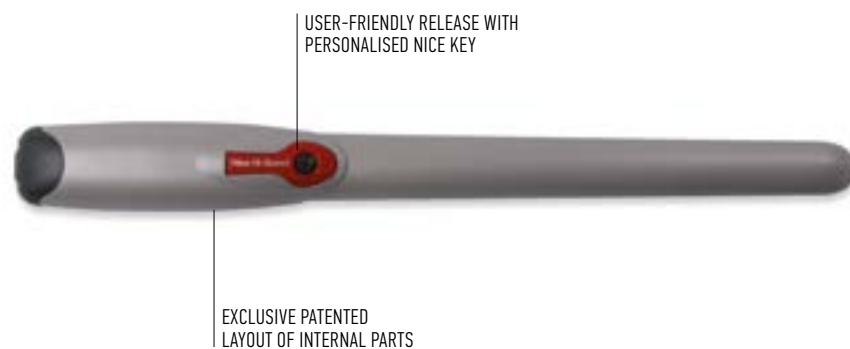

CODE	DESCRIPTION	PACK/PALLET
WG3524HS	IRREVERSIBLE, 24 Vdc, FAST, WITH MAGNETIC ENCODER, MECHANICAL STOP ON OPENING AND CLOSING	20

### TECHNICAL SPECIFICATIONS

CODE	WG3524HS	
<b>ELECTRICAL DATA</b>		
POWER SUPPLY (Vdc)	24	
ABSORPTION (A)	5	
POWER (W)	120	
<b>PERFORMANCE DATA</b>		
SPEED (m/s)	>> 0.04 <<	
FORCE (N)	1500	
WORK CYCLE (CYCLES/HOUR)	30	
<b>DIMENSIONAL AND GENERAL DATA</b>		
PROTECTION LEVEL (IP)	44	
WORKING TEMP. (°C MIN/MAX)	-20 ÷ +50	
DIMENSIONS (mm)	920x98x95 h	
WEIGHT (kg)	6	

### UTILISATION LIMITS

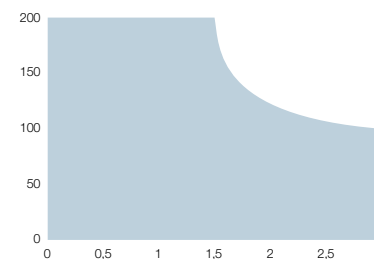

### DIMENSIONS

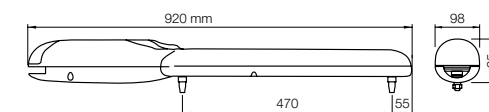

# TOONA 5 HS

SOLEMYO OPERA BLUEBUS 24V

For hi-speed automation of swing gates with leaves up to 5 m or 400 kg, ideal for residential and industrial applications.

24 Vdc, electromechanical gear motor, surface mounted, with magnetic encoder.

### Quick manoeuvres:

90° opening in about 16\* seconds.

**Reliable:** the magnetic encoder ensures the safeguard of set values over time and precise obstacle detection.

**Silent:** patented layout of internal parts and lead nut in bronze.

**Sturdy:** thanks to the housing, made up of two tough aluminium shells with polyester paint finish; more resistant to atmospheric agents. Internal moving parts completely in steel, light alloys and technopolymers.

**Generously sized and practical connection compartment:** rapid and easy access from above to internal parts located in the upper section of the motor.

**Simple installation and maintenance:** with built-in capacitor.

### Moonclever control unit MC824H:

- simple programming, by means of a single key;
- automatic memorization of limit switches on opening and closing with self-learning function;
- automatic fault diagnostics;
- programming of pause time;
- pedestrian pass door;
- deceleration on opening and closing;
- obstacle detection with dual technology;
- operation in event of power failure by means of optional rechargeable batteries (PS324);
- provision for connection of latest generation resistive sensitive edges.

\*Considering standard installation, excluding acceleration and deceleration.

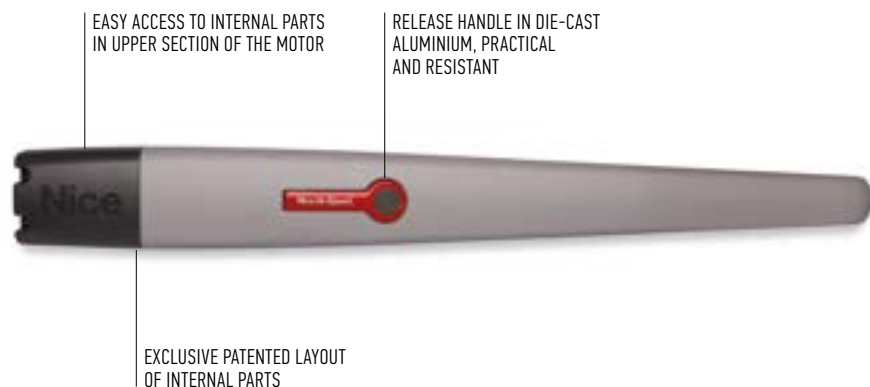

CODE	DESCRIPTION	PACK/PALLET
T05024HS	IRREVERSIBLE, 24 Vdc, FAST, WITH MAGNETIC ENCODER, MECHANICAL STOP ON OPENING AND CLOSING	20

### TECHNICAL SPECIFICATIONS

CODE	T05024HS
<b>ELECTRICAL DATA</b>	
POWER SUPPLY (Vdc)	24
ABSORPTION (A)	5
POWER (W)	120
<b>PERFORMANCE DATA</b>	
SPEED (m/s)	>> 0.025 <<
FORCE (N)	1800
WORK CYCLE (CYCLES/HOUR)	95
<b>DIMENSIONAL AND GENERAL DATA</b>	
PROTECTION LEVEL (IP)	44
WORKING TEMP. (°C MIN/MAX)	-20 ÷ +50
DIMENSIONS (mm)	965x115x105 h
WEIGHT (kg)	7.5

### UTILISATION LIMITS

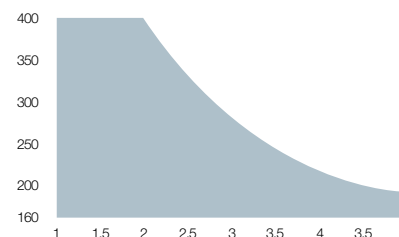

### DIMENSIONS

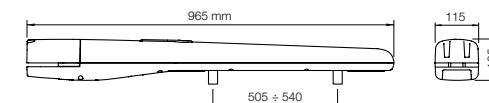



# TOONA 6 HS

SOLEMYO OPERA BLUEBUS 24V

## For hi-speed automation of swing gates with leaves up to 6 m or 1450 kg.

24 Vdc electromechanical gear motor, surface mounted, with magnetic encoder.

### The most powerful:

ideal for industrial applications, designed for intensive use.

### Quick manoeuvres:

90° opening in about 30\* seconds.

**Reliable:** the magnetic encoder ensures the safeguard of set values over time and precise obstacle detection.

**Silent:** patented layout of internal parts and lead nut in bronze.

**Sturdy:** thanks to the housing, made up of two tough aluminium shells with polyester paint finish; more resistant to atmospheric agents.

Internal moving parts completely in steel, light alloys and technopolymers.

### Generously sized and practical connection compartment:

rapid and easy access from above to internal parts located in the upper section of the motor.

### Simple installation and maintenance:

with built-in capacitor.

### Moonclever control unit MC824H:

- simple programming, by means of a single key;
- automatic memorization of limit switches on opening and closing with self-learning function;
- automatic fault diagnostics;
- programming of pause time;
- pedestrian pass door;
- deceleration on opening and closing;
- obstacle detection with dual technology;
- operation in event of power failure by means of optional rechargeable batteries (PS324);
- provision for connection of latest generation resistive sensitive edges.

\*Considering standard installation, excluding acceleration and deceleration.

CODE	DESCRIPTION	PACK/PALLET
TO6024HS	IRREVERSIBLE, 24 Vdc, FAST, WITH MAGNETIC ENCODER, MECHANICAL STOP ON OPENING AND CLOSING	20

### TECHNICAL SPECIFICATIONS

CODE	TO6024HS
<b>ELECTRICAL DATA</b>	
POWER SUPPLY (Vdc)	24
ABSORPTION (A)	5
POWER (W)	120
<b>PERFORMANCE DATA</b>	
SPEED (m/s)	>> 0.016 <<
FORCE (N)	2200
WORK CYCLE (CYCLES/HOUR)	41
<b>DIMENSIONAL AND GENERAL DATA</b>	
PROTECTION LEVEL (IP)	44
WORKING TEMP. (°C MIN/MAX)	-20 ÷ +50
DIMENSIONS (mm)	1200x128x150 h
WEIGHT (kg)	15

### UTILISATION LIMITS

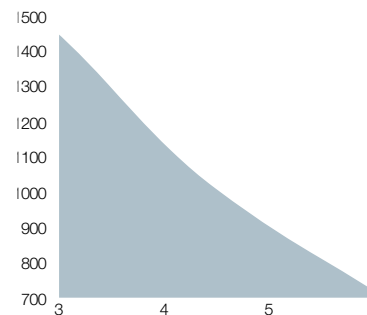

### DIMENSIONS

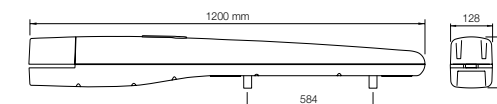

EASY ACCESS TO INTERNAL PARTS IN UPPER SECTION OF THE MOTOR

RELEASE HANDLE IN DIE-CAST ALUMINIUM, PRACTICAL AND RESISTANT

EXCLUSIVE PATENTED LAYOUT OF INTERNAL PARTS

TOUGHER HOUSING SHELL, MADE UP OF TWO STURDY SHELLS



**HI-SPEED QUICK TRANSIT**  
IDEAL FOR COMMERCIAL AND INDUSTRIAL NEEDS



# HYKE HS

SOLEMYO OPERA BLUEBUS 24V 230V

**For hi-speed automation of swing gates with leaves up to 3 m or 270 kg**, ideal for residential applications even with large columns.

24 Vdc electromechanical gear motor with articulated arm, surface mounted, with magnetic encoder.

**Ideal for intensive use and quick manoeuvres:**  
90° opening in about 10 seconds.

**Ultra-powerful and reliable:** thanks to the torque of 500 Nm and encoder technology, for millimetric precision and reliability.

**Safe movement** with dual technology obstacle detection.

## Sturdy

thanks to the housing in aluminium with polyester paint finish, resistant to atmospheric agents.

**Two irreversible 24 Vdc versions** with limit switches on opening and closing: with built-in control unit (HK7024) and without control unit (HK7224).

**Practical and quick installation:** the articulated arm is adjustable in length for maximum flexibility.

**Simple and precise limit switch adjustment:** mechanical stops and micrometric adjustment screws.

**No black out:** with the optional batteries (PS124) housed inside the gear motor.

## Built-in control unit (HK7024):

- simple programming via a single key;
- self-learning of opening and closing limit positions;
- automatic fault diagnostics;
- pause time programming;
- pedestrian pass door;
- deceleration on opening and closing;
- obstacle detection with dual technology;
- provision for connection of latest generation sensitive edges.



ADJUSTABLE ANTI-CRUSHING ARM

DIE CAST ALUMINIUM HOUSING



CODE	DESCRIPTION	PACK/PALLET
HK7024HS	IRREVERSIBLE 24 Vdc, FAST, WITH MAGNETIC ENCODER, COMPLETE WITH ARTICULATED ARM AND BUILT-IN CONTROL UNIT	12
HK7224HS	IRREVERSIBLE 24 Vdc, FAST, COMPLETE WITH ARTICULATED ARM WITHOUT CONTROL UNIT	12

## TECHNICAL SPECIFICATIONS

CODE	HK7024HS	HK7224HS
<b>ELECTRICAL DATA</b>		
POWER SUPPLY (Vac 50/60HZ)	230	-
POWER SUPPLY (Vdc)	-	24
ABSORPTION (A)	1.5	6
POWER (W)	300	140
<b>PERFORMANCE DATA</b>		
SPEED (rpm)	>> 2 <<	
TORQUE (Nm)	500	
WORK CYCLE (CYCLES/HOUR)	40	
<b>DIMENSIONAL AND GENERAL DATA</b>		
PROTECTION LEVEL (IP)	54	
WORKING TEMP. (°C MIN/MAX)	-20 ÷ +50	
DIMENSIONS (mm)	290x210x320 h	
WEIGHT (kg)	10.5	9.5

## UTILISATION LIMITS

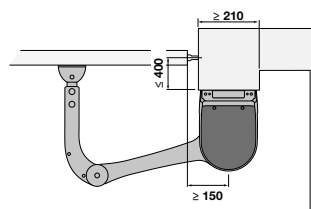

## DIMENSIONS

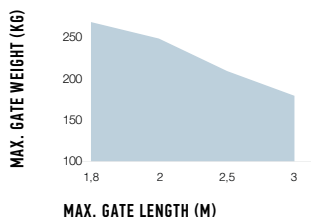
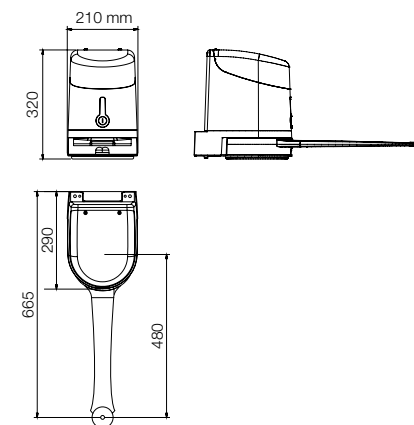

The shape, the height of the gate and the weather conditions can considerably reduce the values shown in the graph to the side.



**HI-SPEED** TOTAL DISCRETION AND SECURITY  
FOR EVEN THE MOST ELEGANT ENVIRONMENTS



# M-FAB HS

SOLEMYO OPERA BLUEBUS 24V

**For hi-speed automation of swing gates with leaves up to 3 m or 300 kg., underground installation, ideal for residential applications.**

24 Vdc electromechanical gear motor, with magnetic encoder.

**Ideal for intensive use and quick manoeuvres:**

90° opening in about 8 seconds.

**Foundation boxes externally chamfered, Fab Box with mechanical stop on opening:**

- in stainless steel (MECX), ideal for use in extreme conditions,
- with the cataphoresis paint finish (MECF), highly resistant to corrosion.

**Reliable and resistant:** motors made up of solid internal parts in metal. New IP67 waterproof die cast aluminium.

**Total freedom of choice:** release from inside and outside, two key-operated models or freely compatible lever version and easily activated with just one hand.

**Simple to use:** mechanical stop system on closure. Standard opening max. 110°, optional opening 360°.

**Totally compatible** with the previous Metro series.

**Moonclever MC824H control unit:**

- simple programming, by means of a single key;
- self-learning of opening and closing limit positions;
- automatic fault diagnostics;
- programming of pause time;
- pedestrian pass door;
- deceleration on opening and closing;
- obstacle detection with dual technology;
- operation in event of power failure by means of optional rechargeable batteries (PS324);
- provision for connection of latest generation resistive sensitive edges.

EVEN MORE RELIABLE AND RESISTANT



WATERPROOF, WITH IP67 PROTECTION RATING

EXTERNALLY CHAMFERED FAB BOX

CODE	DESCRIPTION	PACK/PALLET
MFAB3024HS	IRREVERSIBLE 24 Vdc, FAST, WITH MAGNETIC ENCODER, COMPLETE WITH CONNECTING LEVER AND MECHANICAL STOP FOR THE CLOSING MANOEUVRE	18

CODE	DESCRIPTION	PACK/PALLET
MECX	EXTERNALLY CHAMFERED FOUNDATION BOX IN STAINLESS STEEL WITH MECHANICAL STOP ON OPENING	20
MECF	EXTERNALLY CHAMFERED FOUNDATION BOX WITH CATAPHORESIS FINISH WITH MECHANICAL STOP ON OPENING	20

**NOTE:** key release mechanism, freely compatible with selection of models MEA2 and MEA3 motor.

## TECHNICAL SPECIFICATIONS

CODE	ME3024HS
<b>ELECTRICAL DATA</b>	
POWER SUPPLY (Vdc)	24
ABSORPTION (A)	6
POWER (W)	170
<b>PERFORMANCE DATA</b>	
SPEED (rpm)	>> 2.6 <<
TORQUE (Nm)	180
WORK CYCLE (CYCLES/HOUR)	80
<b>DIMENSIONAL AND GENERAL DATA</b>	
PROTECTION LEVEL (IP)	67
WORKING TEMP. (°C MIN/MAX)	-20 ÷ +50
DIMENSIONS (mm)	390x322x194 h
WEIGHT (kg)	11

## UTILISATION LIMITS

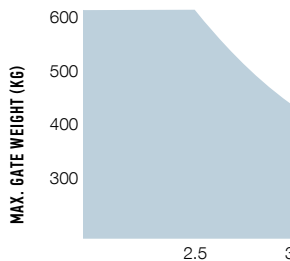

The shape, the height of the gate and the weather conditions can considerably reduce the values shown in the graph to the side.

## DIMENSIONS

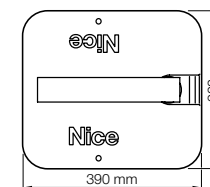
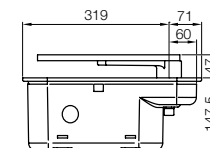



**HI-SPEED** EXCELLENT PERFORMANCE,  
MAXIMUM SECURITY FOR RAPID INTERVENTION





# ROBUS 250/500 HS

SOLEMYO OPERA BLUEBUS 24V

For hi-speed automation of sliding gates weighing up to 250 kg (RB250HS) and up to 500 kg (RB500HS) or up to 8 m long, for residential and industrial applications.

24 Vdc electromechanical gear motor.

**Ideal for intensive use,** with opening and closing speed up to 44 cm/s.

For instance, opening a 4 m gate takes around 10\* seconds with RB250HS and around 9\* seconds with RB500HS.

**User-friendly:** thanks to the Nice BlueBUS technology, the control unit can be connected to up to seven couples of photocells, control, security and signalling devices, using two wires only.

**Practical:** the control unit and PS124 buffer battery (optional) can be connected by means of a simple connector and can be housed directly inside Robus.

**Advanced:** the temperature sensor adapts the motor power to the climatic conditions and at the same time thermal cut-out.

A master/slave selection automatically synchronises two motors. This means it is possible to automate 2-leaf sliding gates set opposite each other.

**Intelligent:** thanks to the obstacle detection system and automatic programming of the working times. Self-diagnosis by means of a flashing light. 8 programming levels.

**Safe:** acceleration and deceleration can be adjusted at the beginning and at the end of each opening and closing manoeuvre.

**Sturdy:** base and release in pressure die cast with easy to open handle.

**Very quiet:** gear motor on bearings.

\*Considering standard installation, excluding acceleration and deceleration.



PRESSURE DIE-CAST ALUMINIUM BASE AND RELEASE, WITH EPOXY PAINTING

CODE	DESCRIPTION	PACK/PALLET
RB250HS	IRREVERSIBLE, 24 Vdc, FAST, WITH INCORPORATED CONTROL UNIT, WITH ELECTROMECHANICAL LIMIT SWITCH, FOR GATES UP TO 250 kg	14
RB500HS	IRREVERSIBLE, 24 Vdc, FAST, WITH INCORPORATED CONTROL UNIT, WITH ELECTROMECHANICAL LIMIT SWITCH, FOR GATES UP TO 500 kg	14

## TECHNICAL SPECIFICATIONS

CODE	RB250HS	RB500HS
<b>ELECTRICAL DATA</b>		
POWER SUPPLY (Vac 50/60 Hz)	230	230
ABSORPTION (A)	2.1	2.2
POWER (W)	430	450
<b>PERFORMANCE DATA</b>		
SPEED (m/s)	>> 0.4 <<	>> 0.44 <<
TORQUE (Nm)	310	360
WORK CYCLE (CYCLES/HOUR)	50	20
<b>DIMENSIONAL AND GENERAL DATA</b>		
PROTECTION LEVEL (IP)	44	
WORKING TEMP. (°C MIN/MAX)	-20 ÷ +50	
DIMENSIONS (mm)	330x195x277 h	330x210x303 h
WEIGHT (kg)	8	11

## DIMENSIONS

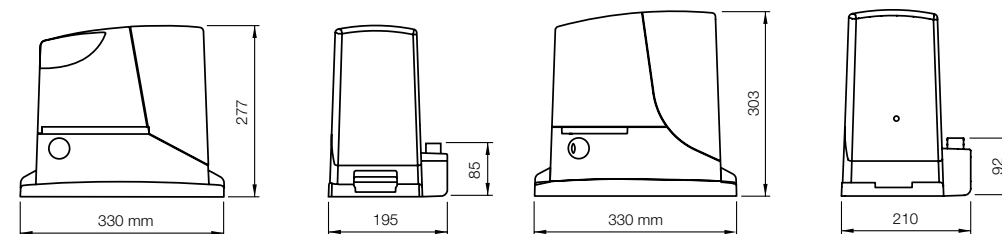

RB250

RB500

# RUN 400/1200 HS

OPERA BLUEBUS 24V

**For hi-speed automation of sliding gates weighing up to 400 kg (RUN400HS) and up to 1200 kg (RUN1200HS), for residential and industrial applications.**

24 Vdc electromechanical gear motor.

**The fastest:** ideal for industrial applications, designed for intensive use.

**Rapid manoeuvres, with opening and closing speed up to 70 cm/s.**

For instance, opening a 4 m gate takes around 6\* seconds with RUN400HS, while opening a 7 m gate takes around 18\* seconds with RUN1200HS.

**User-friendly:** thanks to the Nice BlueBUS technology, the control unit can be connected to up to seven couples of photocells, control, security and signalling devices, using two wires only.

**Practical:** the control unit and PS524 battery charger (to which two B12-B batteries should be added) can be connected by means of a simple connector and can be housed directly inside the motor.

**Advanced:** the temperature sensor adapts the motor power to the climatic conditions and at the same time thermal cut-out. A master/slave selection automatically synchronises two motors. This means it is possible to automate 2-leaf sliding gates set opposite each other.

**Intelligent:** thanks to the obstacle detection system and automatic programming of the working times. Self-diagnosis by means of a flashing light. 8 programming levels.

**Safe:** acceleration and deceleration can be adjusted at the beginning and at the end of each opening and closing manoeuvre.

**Sturdy:** base and release in pressure die cast with easy to open handle.

**Very quiet:** gear motor on bearings.

\*Considering standard installation, excluding acceleration and deceleration.

CODE	DESCRIPTION	PACK/PALLET
RUN400HS	IRREVERSIBLE, 24 Vdc, FAST, WITH INCORPORATED CONTROL UNIT, WITH ELECTROMECHANICAL LIMIT SWITCH, FOR GATES UP TO 400 kg	12
RUN1200HS	IRREVERSIBLE, 24 Vdc, FAST, WITH INCORPORATED CONTROL UNIT, WITH ELECTROMECHANICAL LIMIT SWITCH, FOR GATES UP TO 1200 kg	12

## TECHNICAL SPECIFICATIONS

CODE	RUN400HS	RUN1200HS
<b>ELECTRICAL DATA</b>		
POWER SUPPLY (Vac 50/60 Hz)	230	230
ABSORPTION (A)	2	2
POWER (W)	415	415
<b>PERFORMANCE DATA</b>		
SPEED (m/s)	>> 0.7 <<	>> 0.37 <<
TORQUE (Nm)	409	790
WORK CYCLE (CYCLES/HOUR)	60	60
<b>DIMENSIONAL AND GENERAL DATA</b>		
PROTECTION LEVEL (IP)	44	
WORKING TEMP. (°C MIN/MAX)	-20 ÷ +50	
DIMENSIONS (mm)	400x255x387 h	
WEIGHT (kg)	24.5	

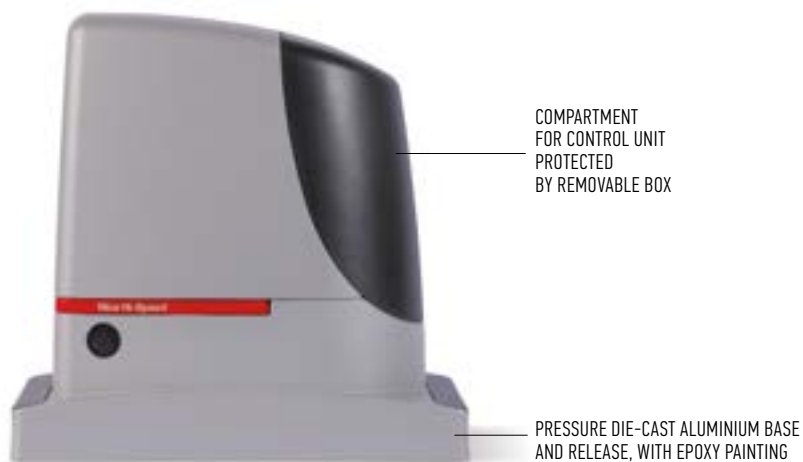

## DIMENSIONS

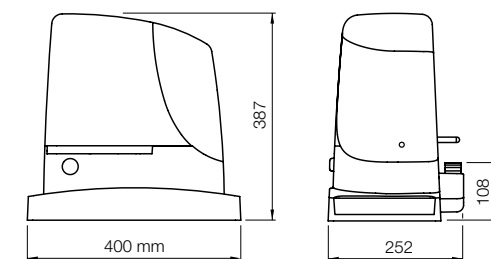

# NICE&SAFE IT'S REALLY EASY TO MAKE YOUR AUTOMATION SAFE!

## 100% SECURITY

THANKS TO THE ADVANCED TECHNOLOGY OF NICE CONTROL UNITS AND SECURITY DEVICES, HI-SPEED AUTOMATION SYSTEMS ARE A SYNONYM FOR RELIABILITY, SECURITY AND COMFORT, **IN COMPLIANCE WITH EUROPEAN STANDARDS AND REGULATIONS.**

## NO WIRED CONNECTIONS

AUTOMATION IS EVEN SAFER THANKS TO THE WIRELESS DETECTION AND COMMUNICATION SYSTEM BETWEEN THE SENSITIVE EDGES AND THE CONTROL UNIT, ENSURING **PRECISE AND IMMEDIATE OBSTACLE DETECTION.**

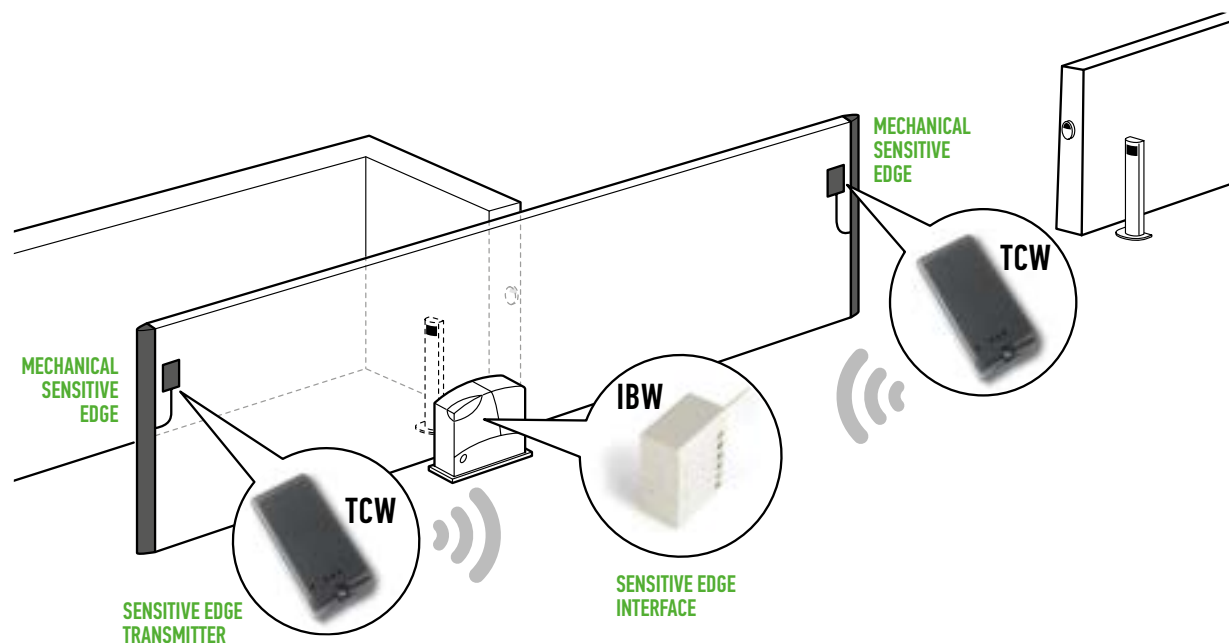

TCW2



TCW1



TCB65



CMA



NSFS

### TCW SENSITIVE EDGE SENSORS

UNBEATABLE SAFETY IS GUARANTEED THANKS TO THE WIRELESS SYSTEM FOR DETECTION AND COMMUNICATION BETWEEN SENSITIVE EDGE, INTERFACE AND CONTROL UNIT, ALLOWING SWIFT ACTION WHEN AN OBSTACLE IS DETECTED.

### RESISTIVE SENSITIVE EDGES

PRECISE AND RELIABLE, THEY CAN PROMPTLY COMMUNICATE WITH THE CONTROL UNIT IN CASE OF FAULTS IN THE SYSTEM, FOR EXAMPLE IF THE PRODUCT ITSELF HAS BROKEN DOWN. THEY CAN BE INSTALLED QUICKLY, ADAPTING TO ANY KIND OF SITUATION.

### INSTRUMENT FOR IMPACT FORCE MEASUREMENT

THANKS TO THIS TOOL, THE INSTALLER CAN MEASURE ACCURATELY AND PRECISELY THE AUTOMATION IMPACT FORCE, AND ADJUST IT IN AN OPTIMAL WAY.

# CONTROL DEVICES

## THE NEW NICE STYLISH TRANSMITTERS FOR GATES AND DOORS



### ERA-ONE

EASE AND HANDINESS.

1, 2, 4 AND 9 CHANNELS, TRANSMITTERS WITH MANAGEMENT OF IDENTITY CODES AND CERTIFICATES, SELF-LEARNING FUNCTION AND BUILT-IN PROXIMITY RECEIVER. THE IDEAL SOLUTION FOR THE MANAGEMENT OF MULTI-USE SYSTEMS.



### ERA-FLOR

A BEST SELLER REVAMPED WITH A STYLISH DESIGN.

1, 2 AND 4 CHANNELS, TRANSMITTERS 433.92 MHz, ROLLING CODE SYSTEM WITH SELF-LEARNING FUNCTION AND SEQUENTIAL CODE FOR MULTIPLE INSERTION.



### ERA-INTI

FASHIONABLE AND MINIATURIZED TRANSMITTERS.

1 AND 2 CHANNELS, TRANSMITTERS 433.92 MHz, ROLLING CODE SYSTEM WITH SELF-LEARNING FUNCTION. AVAILABLE IN 6 DIFFERENT COLORS.

# CONTROL AND SIGNALLING DEVICES

## SWITCHES AND SELECTORS: TAKING CARE OF YOUR COMFORT WITH A NEW, MINIMAL, MODERN AND DISCREET DESIGN



### ERA KEYPAD

DIGITAL SWITCHES FOR SURFACE-MOUNTED, RECESSED, OR 100% WIRELESS INSTALLATION. ALSO AVAILABLE WITH NICE BLUEBUS TECHNOLOGY.



### ERA TRANSPONDER READER

TRANSPONDER PROXIMITY READERS FOR CARDS AND BADGES, SURFACE-MOUNTED INSTALLATION. ALSO AVAILABLE WITH NICE BLUEBUS TECHNOLOGY.



### ERA KEY SWITCH

KEY SWITCHES WITH AUTOMATIC RETURN LOCK, EUROPEAN OR STANDARD CYLINDER. AVAILABLE FOR OUTDOOR OR RECESSED INSTALLATION.

## CONTROL ACCESSORIES: A COMPLETE, VERSATILE AND PRACTICAL RANGE



### ERA PHOTOCELLS SLIM

FIXED SYNCHRONIZED PHOTOCELLS, ALSO WITH NICE BLUEBUS TECHNOLOGY. AVAILABLE IN BURGLAR-RESISTANT VERSION WITH METAL SHELL. IDEAL FOR TIGHT SPACES.



### ERA PHOTOCELLS MEDIUM

FIXED OR POSITIONABLE SYNCHRONIZED PHOTOCELLS, ALSO WITH NICE BLUEBUS TECHNOLOGY. AVAILABLE IN BURGLAR-RESISTANT VERSION WITH METAL SHELL. IDEAL FOR STANDARD INSTALLATION.



### ERA PHOTOCELLS LARGE

FIXED OR POSITIONABLE SYNCHRONIZED PHOTOCELLS, ALSO WITH NICE BLUEBUS TECHNOLOGY. AVAILABLE FOR SURFACE-MOUNTED OR RECESSED INSTALLATION.



### ERA POST

OUTDOOR ALUMINIUM POSTS WITH PROTECTED HOUSING FOR ERA PHOTOCELLS, SWITCHES AND PROXIMITY READERS. AVAILABLE IN TWO HEIGHTS: 500 mm AND 1000 mm.



### ERA LIGHT

FLASHING SIGNALLING LIGHT, EXTREMELY RESISTANT TO SHOCKS. AVAILABLE WITH DIFFERENT POWER SUPPLIES: 230 V, 24 V AND 12 V.



# NICE IS THE SIMPLEST INTEGRATION/ THE WIDEST RANGE/THE BEST CONTROL ELECTRONICS/THE FINEST DESIGN/THE MOST AMAZING AUTOMATION ALL TOGETHER!

## GATE&DOOR

Systems for the automation of gates, garage doors and barriers.

## SCREEN

Systems for the automation of blinds, awnings and sun screens.  
The easiest way to get the right light.

## INDUSTRIAL DOORS

Systems for the automation of industrial applications: sectional and rolling doors, high speed doors and dock levellers.

## HOME SYSTEMS

Integrated management of home alarm and automation systems.

## LIGHTING

A full range of devices for total lighting control.



Nice Love Earth

Nice cares for the environment. Using natural paper it avoids excessive use of raw materials and forest exploitation. Waste is reduced, energy is saved and climate quality is improved.

**Nice**

Nice SpA  
Oderzo TV Italia  
Ph. +39.0422.85.38.38  
info@niceforyou.com

Find out more about Nice products and services on the website:  
[www.niceforyou.com](http://www.niceforyou.com)